



Human Normal Immunoglobulin (10%)
Recombinant Human Hyaluronidase

Infusing HyQvia[®] treatment with a syringe driver pump

A step-by-step guide for patients and caregivers

Additional information following training from your healthcare team

HyQvia is prescribed as replacement therapy to patients who do not have sufficient antibodies, including the following groups:

- Patients with an inborn inability or reduced ability to produce antibodies (primary immunodeficiencies)
- Patients who have developed an inability or reduced ability to produce antibodies (secondary immunodeficiencies) due to disease or environmental factors who suffer from:
 - Severe or recurrent infections
 - Ineffective antimicrobial treatment
 - And either problems with their antibodies (also known as proven specific antibody failure or PSAF) or a serum level of <4 g/l of an antibody called IgG

You can help provide more information on the safety of this medicine by reporting any side effects you may get. See the end of section 4 of the Package Leaflet for how to report side effects.

This guide is intended for use after a patient has been prescribed **HyQvia**



Copyright 2021 @ Takeda Pharmaceutical Company Limited.
All rights reserved. All trademarks are the property of their respective owners.

Visit <https://axian.link/hyq-pat-GBR>
to access a digital guide with
animated instructions.



Introduction

Infusion overview

You have received this step-by-step guide because your healthcare professional has prescribed **HyQvia** treatment for you or the person you are caring for. This guide is designed to help you infuse **HyQvia** using a syringe driver pump. Use this guide for the direct-from-vial method. If you have any questions or concerns about how to infuse **HyQvia**, please discuss them with your healthcare professional.

Infuse HyQvia only after you have been trained by your healthcare professional and have read the information in the Package Leaflet.

Healthcare professional name and phone number:

Visit <https://axian.link/hyq-pat-gbr> to access a digital guide with animated instructions.



The 5 steps to infusing HyQvia treatment



Infuse **HyQvia** only after you have been trained by your healthcare professional and have read the information in the **HyQvia** package leaflet.

What you'll need

Below are the supplies you'll need to infuse **HyQvia** treatment. Your supplies may look slightly different.

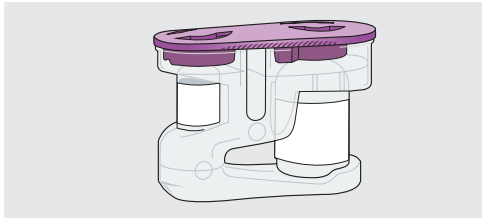

HyQvia vial(s) at room temperature

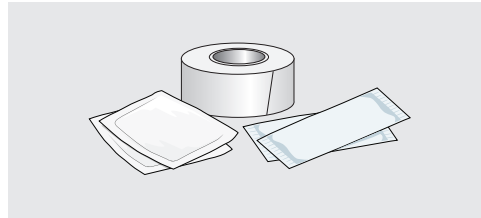

Alcohol swabs, tape and clean, sterile bandage*

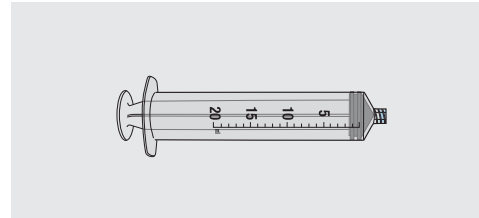

20 mL syringe(s)[†]

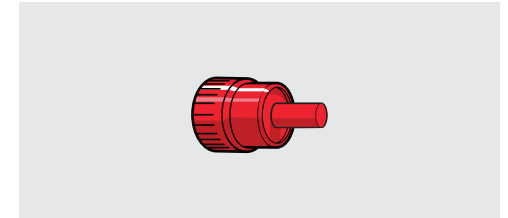

Optional: sterile tip caps (one per syringe)

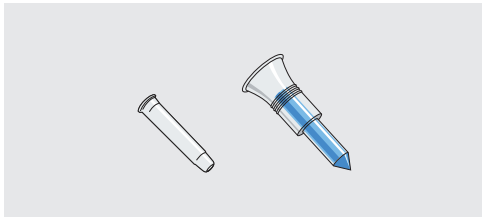

Non-vented device or needle (one per **HY** vial)

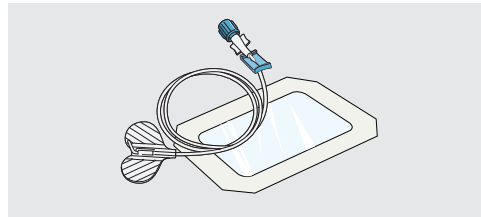

Subcutaneous needle set with a sterile dressing (one per infusion site)

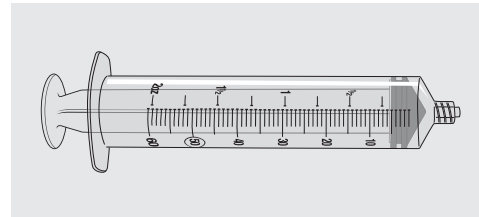

50 or 60 mL syringe(s)[†]

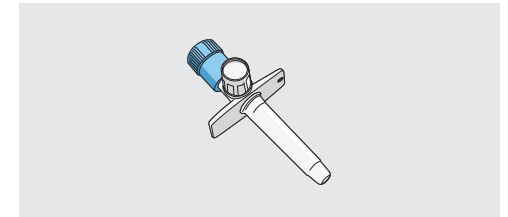

Vented spike(s)

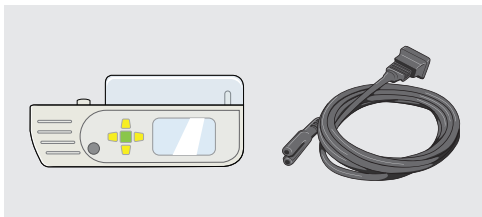

Syringe driver pump power supply and manual



Sharps container

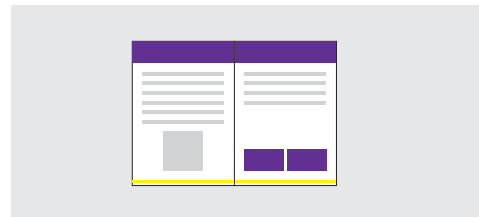

Log book

*Wear gloves if instructed by your healthcare professional.

[†]These are the recommended syringe volumes.

How they fit together

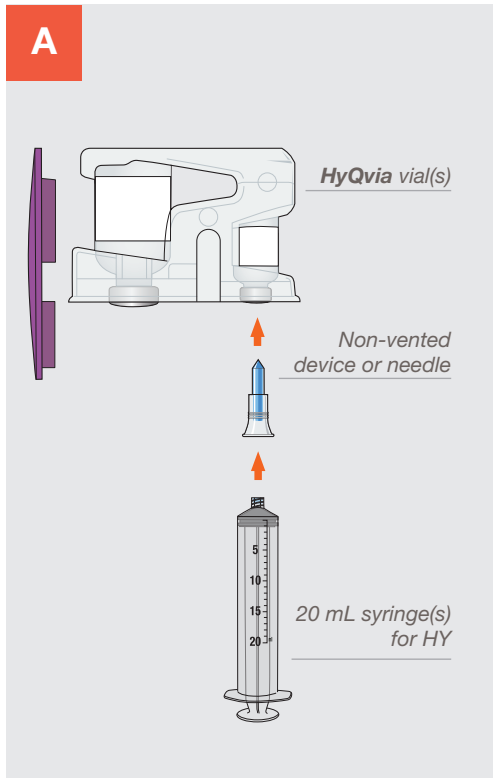

Transfer the **HY** into the syringe(s)

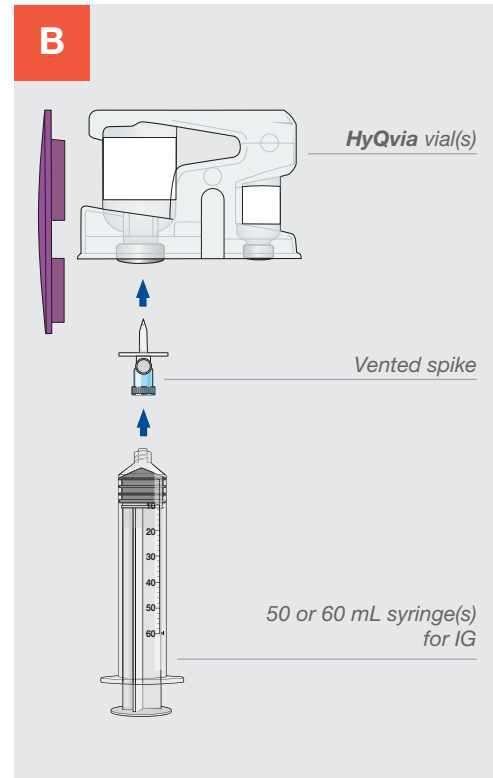

Transfer the **IG** into the syringe(s)

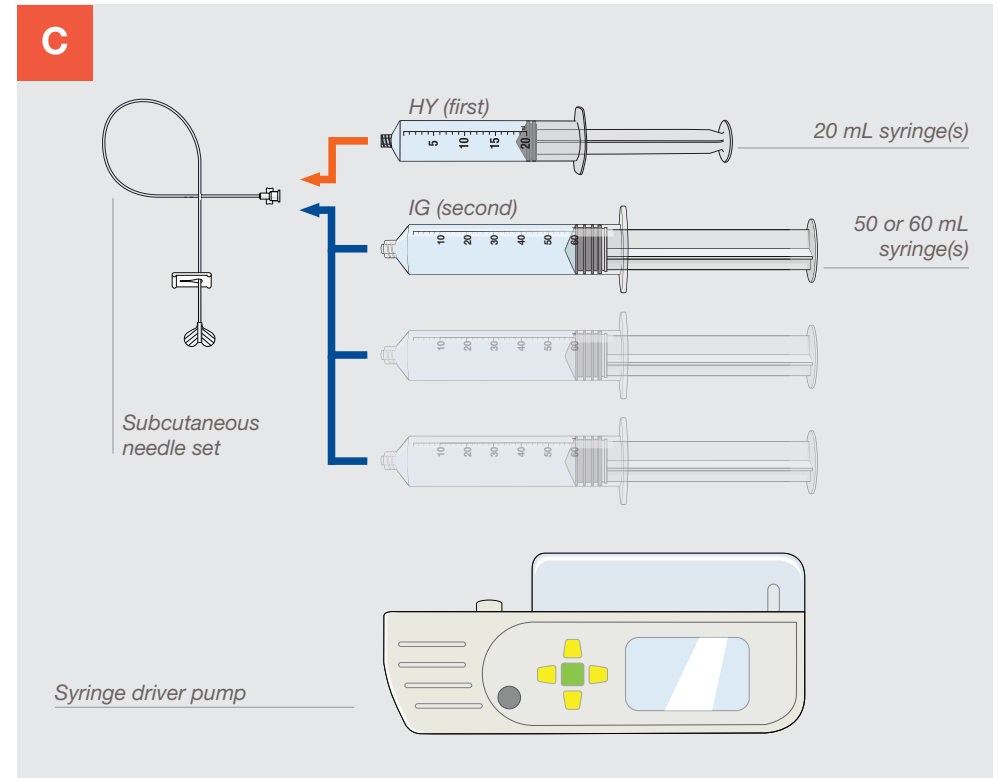

1. Infuse* the **HY** manually (**first**)
2. Infuse* the **IG** using syringe driver pump (**second**)

*This diagram is an example. The number of syringes required is dependent on your prescribed dose.

STEP 1

Get ready



Remove **HyQvia** from the box and inspect it. Check the colour and expiry date. Make sure the liquid isn't cloudy and doesn't have particles in it. Allow **HyQvia** to reach room temperature (this may take up to 60 minutes). Do not use heating devices including microwaves. Do not shake **HyQvia**.

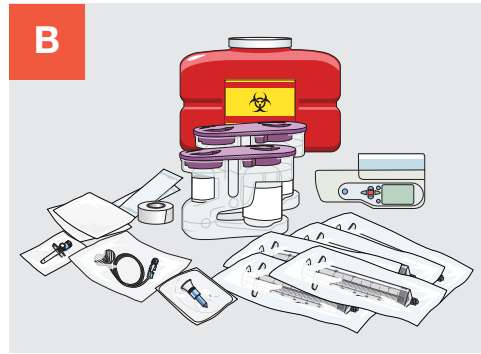

Gather your supplies.

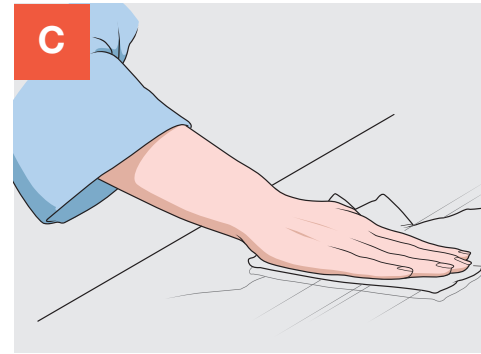

Clean your work area.



Wash your hands thoroughly.



Open supplies as instructed by your healthcare professional.

STEP 2

Prepare the HY

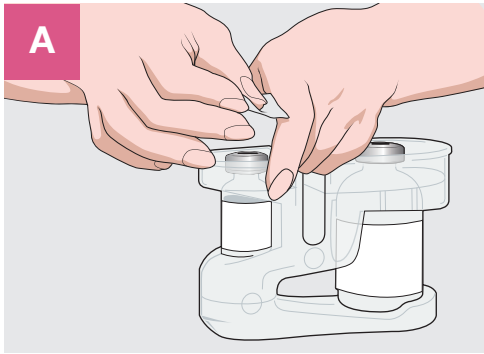

Remove the cap. Clean each vial of **HY** by wiping the stopper with an alcohol swab and allowing to dry for at least 30 seconds. Prepare a label for the **HY** syringe and set it aside.

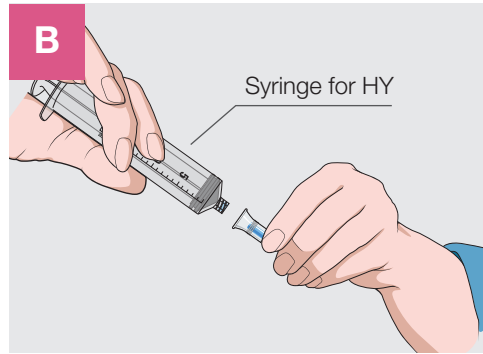

Remove the 20 mL sterile syringe from its package.* Attach a non-vented device or needle to the syringe.

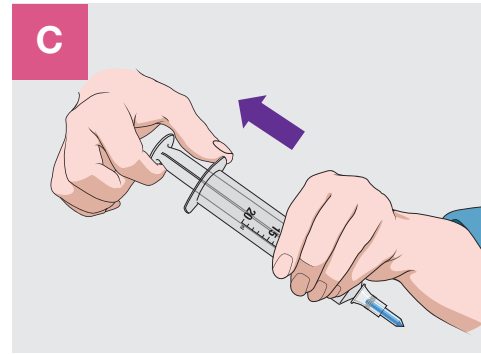

Pull back on the plunger to fill the syringe with air (an amount equal to the full amount of **HY**).

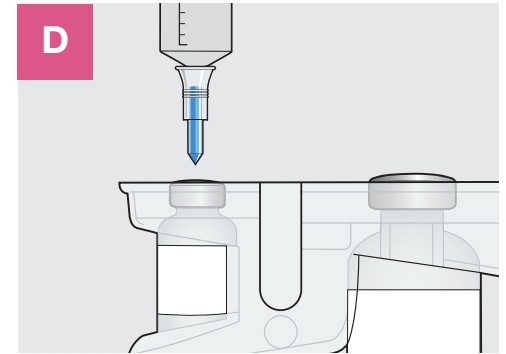

Insert the non-vented device or needle into the centre of the **HY** vial stopper. Push the air into the vial.

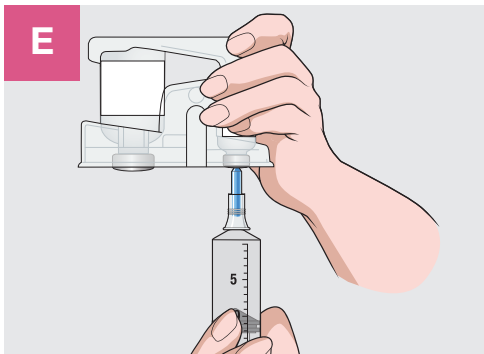

Turn the vial upside down. Pull back on the plunger to withdraw all of the **HY** into the syringe. Repeat steps C to E if more than one vial of **HY** is needed for your dose.

Use the same syringe, if possible.

*This is the recommended syringe volume.



TIP

Cover each syringe with a sterile tip cap when drawing up multiple syringes.

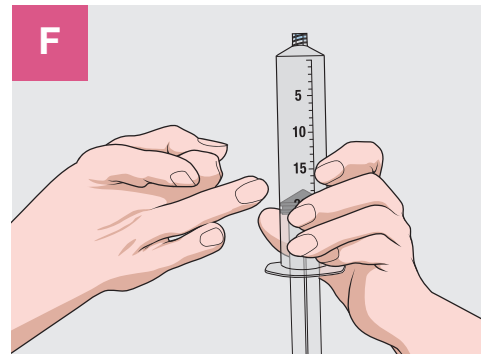

When the full dose has been transferred into the syringe, hold the syringe upright and **gently tap it to remove air bubbles**. Then slowly push the plunger until the **HY** reaches the tip of the barrel.

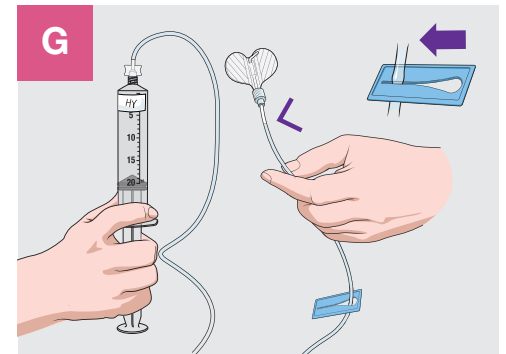

Attach the subcutaneous needle set to the **HY** syringe. Slowly push the plunger to fill the needle set tubing to the needle wings. Close the clamp on the needle set tubing. **Label the syringe HY.**

STEP 3

Prepare the IG

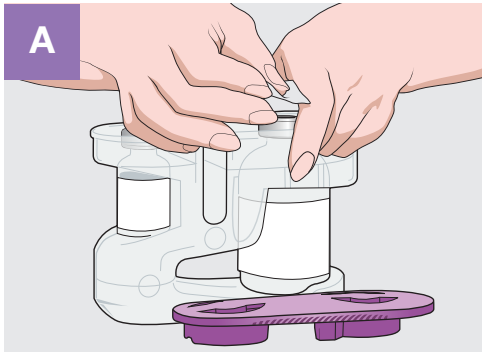

Clean each vial of **IG** by wiping the stopper with an alcohol swab and allow to dry for at least 30 seconds.

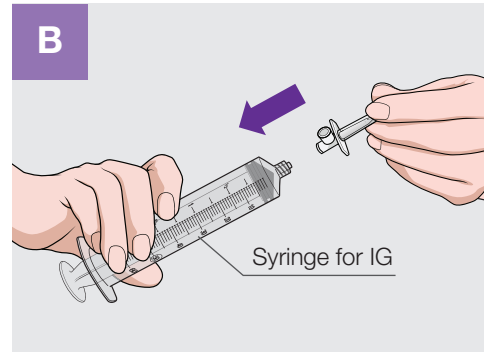

Open the larger 50 or 60 mL sterile syringe from its package.* Attach the syringe to a vented spike.

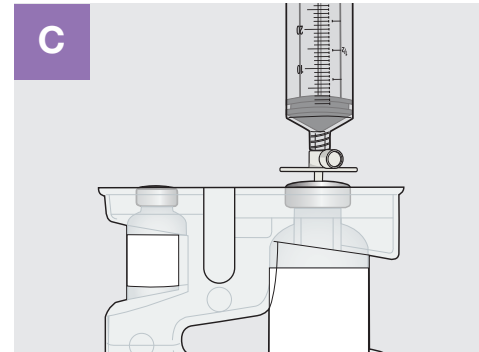

Insert the vented spike straight down into the **IG** vial stopper. Then turn the vial upside down and pull on the plunger to withdraw the desired dose of **IG**. Repeat steps A to C if using multiple vials to achieve the desired dose.

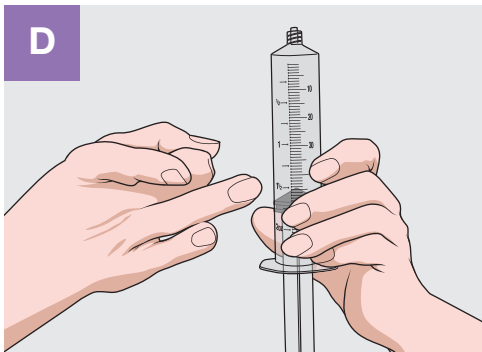

Gently tap the syringe to remove bubbles. Slowly push the plunger until the **IG** reaches the tip of the barrel.

*These are the recommended syringe volumes.

TIPS

Cover each syringe with a sterile tip cap when drawing up multiple syringes.

If using a non-vented device or needle to withdraw the **IG**, attach a larger 50 mL or 60 mL syringe to the non-vented device or needle. Pull back on the plunger to fill the syringe with air equal to the amount of **IG** you will be taking from the vial. Insert the non-vented device or needle into the centre of the **IG** vial stopper. Push the air into the vial. Then turn the vial upside down and pull on the plunger to withdraw the desired amount of **IG** into the syringe.

STEP 4

Infuse HyQvia

Remember: HY before IG

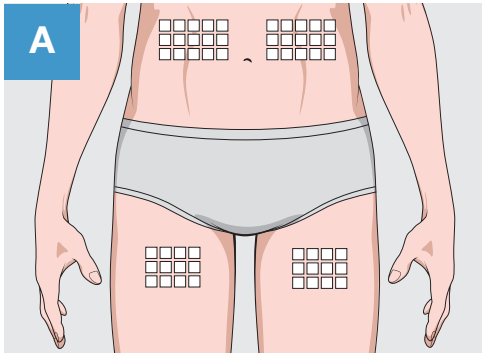

Choose an infusion site (or sites) in either the abdomen or thigh. Avoid bony areas, visible blood vessels, scars and any areas of inflammation or infection. Rotate your infusion sites to opposite sides of the body between infusions.* **Clean the infusion site(s) with an alcohol swab**, as instructed by your healthcare professional. Allow to dry for at least 30 seconds.

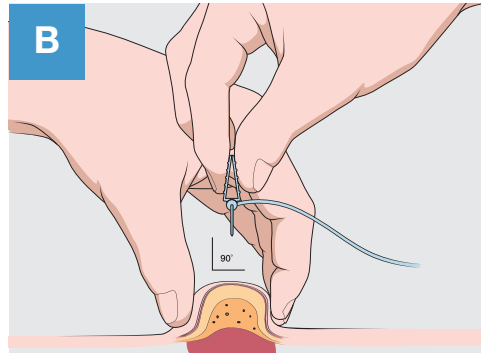

Remove the subcutaneous needle cover. Pinch at least 2.0 to 2.5 cm of your skin. Insert the needle with a rapid motion straight into the skin at a 90-degree angle. Open the needle set wings and secure the needle in place with a sterile dressing.

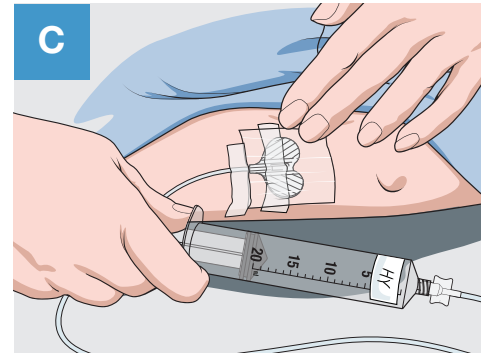

If more than one infusion site is used, repeat steps A through C. Open the clamp on the needle set. Check for proper needle placement before starting the infusion, as instructed by your healthcare professional.

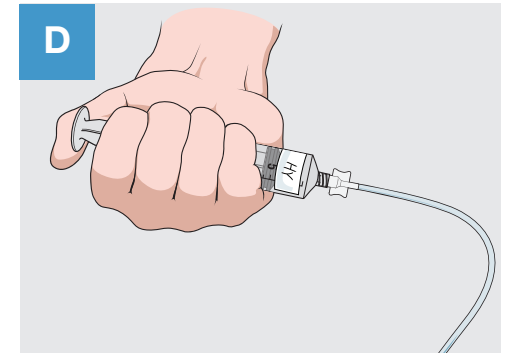

Slowly push the plunger of the smaller syringe with the recombinant **HY** at an initial rate of 1 to 2 mL per minute and increase as tolerated. If more than one site is used, divide the **HY** equally between sites.

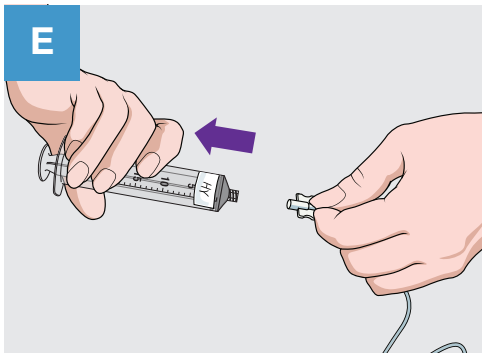

When all of the **HY** has been infused, detach the smaller syringe from the needle set. Do not remove the needle from your infusion site(s).

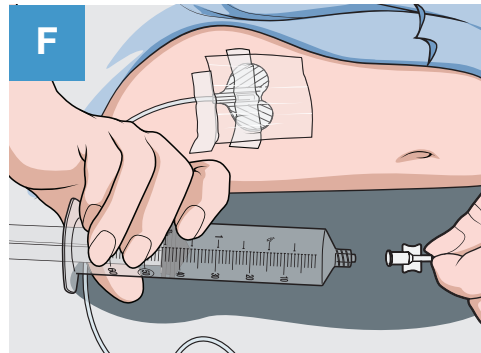

Attach the **IG** syringe to the same subcutaneous needle set.

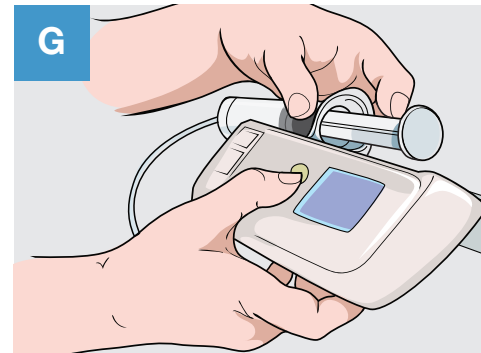

Insert the **IG** syringe into the pump and start the pump at the rate prescribed by your healthcare professional and following the manufacturer's instructions for preparing the pump. **The IG infusion should be started within 10 minutes of completing the HY infusion.**

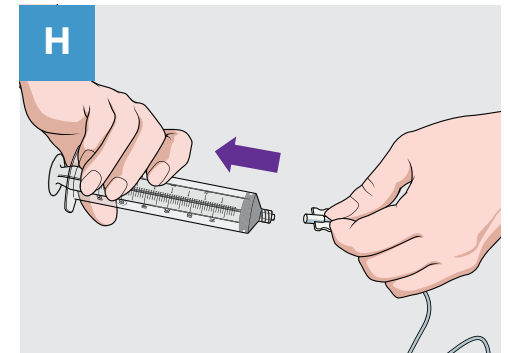

When the syringe is empty, remove the syringe from the pump and detach it from the subcutaneous needle set. Repeat steps F to H for each additional syringe of **IG**.

*For patients with a body weight of <40kg, select sites on opposite sides of body if instructed to infuse in 2 sites for doses above 300 mL. For patients with a body weight of >40kg, select sites on opposite sides of body if instructed to infuse in 2 sites for doses above 600 mL.

STEP 5

Finish up

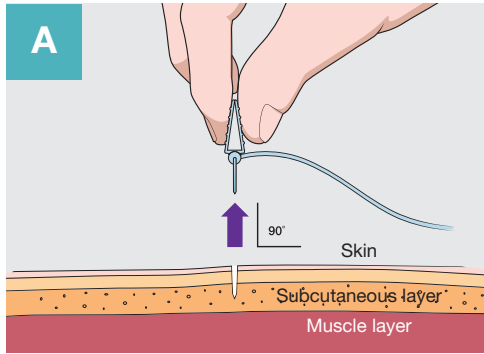

When the infusion is complete, attach a syringe containing normal saline (0.9% Sodium Chloride [NaCl] solution) to the needle set to flush it and push the **IG** up to the needle wings, if instructed by your healthcare professional. Remove the subcutaneous needle set by loosening the sterile dressing on all edges. Pull the needle wings straight up and out. Gently place the clean, sterile bandage over the infusion site.

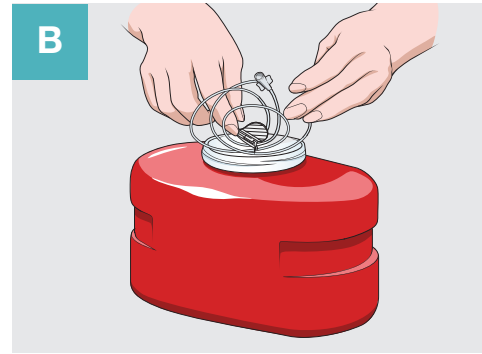

Dispose of the needle set in the sharps container and throw away any unused product in the vial and disposable supplies, as recommended by your healthcare professional.

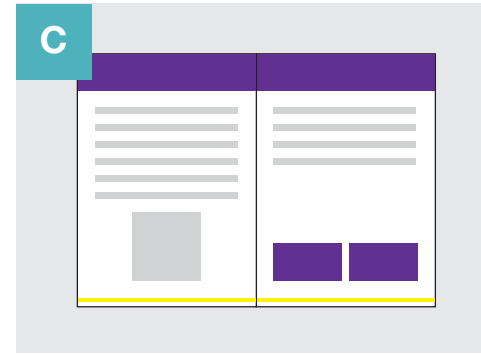

Record the infusion details in your log book.

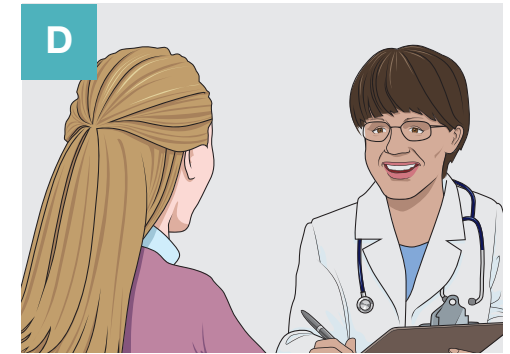

Follow up with your healthcare professional as directed.

What it looks like when you infuse HyQvia treatment

Following your infusion with **HyQvia**, you may experience swelling at the infusion site. Swelling should only last for a few days.

Before, during and after HyQvia treatment

Example of a patient on **HyQvia**. Your body may react to your **HyQvia** infusion in the same way, or differently.



Before **HyQvia** infusion



Right after **HyQvia** infusion



24 hours after infusion

HyQvia infused: 235 mL (volume infused as per the healthcare professional's guidance based on this patient's specific clinical condition; it may be different for you).

What are the possible side effects of HyQvia treatment?

Local site reactions occur at the infusion site. These reactions usually go away within a few days. The most common local side effects include: infusion site pain, including mild-to-moderate discomfort and tenderness, redness, swelling, itching, hardening and rash.

In clinical studies, there were no long-term changes to the skin. Any long-term inflammation, lumps (nodules), or inflammation that occurs at the infusion site and lasts more than a few days should be reported to your healthcare professional.

Generalised side effects are not limited to the infusion site and can occur throughout the body. The most common generalised side effects include: headache, tiredness, nausea, vomiting, diarrhoea, abdominal pain, muscle or joint pain, chest pain, fever and feeling weak or unwell.

Serious side effects

Infusions of medicines like **HyQvia** can occasionally result in serious, but rare, allergic reactions. You may experience a sudden fall in blood pressure and, in isolated cases, anaphylactic shock. Healthcare professionals are aware of these possible side effects and will monitor you during and after the initial infusions.

Typical signs or symptoms include: feeling light-headed, dizzy or faint, skin rash and itchiness, swelling in the mouth or throat, difficulty breathing, wheezing, abnormal heart rate, chest pain, blueness of lips or fingers and toes and blurred vision.

Tell your healthcare professional immediately if you notice any of these signs during the infusion.

Managing possible side effects of HyQvia treatment

Local side effects

The following local reactions may occur at the site of infusion and usually go away within a few days. Always contact your healthcare professional to find out how best to manage any local reaction that increases in severity or persists for more than a few days.

Discomfort or pain at the infusion site when inserting the subcutaneous needle

- Remove the needle because it may be in your muscle
- Contact your healthcare professional if severe pain does not fade when you remove the needle or if it happens each time you infuse
- Talk to your healthcare professional or speciality pharmacy about changing the length of your needle; it may be too long for you. The thickness of subcutaneous tissue can be different from person to person depending on age, gender, body mass index, and the site of infusion
- Note in your log book that this site may not work for you

Discomfort, pain, or redness at the infusion site during or after your infusion

- Please talk to your healthcare professional, who may slow or stop the infusion
- Place a clean, warm or cold washcloth as directed by your healthcare professional for short periods (no longer than 10 minutes) on your irritated site
- Talk to your healthcare professional about a possible allergy to your tape or dressing or the possible use of a mild pain reliever

Swelling at or around the infusion site

After **HyQvia** infusion, a temporary swelling can occur due to the volume of fluid infused.

- Place a clean, warm washcloth for short periods (no longer than 5 to 10 minutes) on the swelling
- Your healthcare professional may advise you to walk around or gently massage the swelling

Itching or rash at or around the infusion site

- Slow or stop the infusion
- Place a clean, cold washcloth for short periods (no longer than 10 minutes) on your itchy site
- When priming the subcutaneous needle, avoid coating the needle with drops of the **HyQvia** treatment
- Talk to your healthcare professional about the possible use of an antihistamine, if recommended

If you experience uncontrollable itching or rash/hives, stop your infusion immediately and contact your healthcare professional or emergency services; these could be signs of a serious allergic reaction

Generalised (systemic) side effects

Generalised side effects affect the whole body rather than a specific part. The most common generalised side effects include:

Headache

- Talk to your healthcare professional about using an over-the-counter pain reliever
- Contact your healthcare professional if the headache persists or worsens

Tiredness

- Rest quietly after the infusion
- Go to bed early the day of the infusion

Fever

- Talk to your healthcare professional about using an over-the-counter medicine to reduce the fever
- Contact your healthcare professional if the fever persists or worsens

Other less frequent side effects are listed in the **HyQvia** Package Leaflet including serious but rare allergic reactions. It's also possible that you may experience side effects that are not discussed in the **HyQvia** Package Leaflet. Please talk to your healthcare professional if you experience any side effects, particularly those that are not listed in the Package Leaflet, are severe, or last longer than a couple of days.

Please note: the suggestions above should not replace your healthcare professional's direction/advice.

You can also report side effects directly via the Yellow Card Scheme at www.mhra.gov.uk/yellowcard or search for MHRA Yellow Card in the Google Play or Apple App Store. By reporting side effects, you can help provide more information on the safety of this medicine.

Patient and caregiver resources

Helpful PID communities and support organisations

Joining community groups and patient advocacy organisations is another way you can take control of your primary immunodeficiency (PID). You may find these organisations helpful.

International Patient Organisation for Primary Immunodeficiencies (IPOP)

<http://www.ipopi.org/>

Jeffrey Modell Foundation

<http://info4pi.org/>

European Society for Immunodeficiencies (ESID)

<http://esid.org/>

Immunodeficiency UK

<http://www.immunodeficiencyuk.org/>

UK Primary Immune-deficiency Patient Support Charity (UKPIPS)

<https://ukpips.org.uk/>

